



DISTRIBUITO DA

SST[®]

ENGINEERING SOLUTIONS

WWW.SST-ITALIA.IT

COLLECTION / 2022

PRODUCT CATALOGUE SPORT

COLLECTION / 2022

OVERVIEW

SPORT	3
WING	5
SPEED	11
PERFORMANCE	15
BIKE	15
FLOW	20
LIFESTYLE	23
SHOUT	23
SHOUT RX	31
SNOW	37
CLASSIC	37
MAGNETRON	47
DIRT	52
MX/DH	52

SPORT

WING
DESIGNED TO **WING
RIDE**





POLARIZED LENSES

Polarized lenses reduce the effects of glare by reflected light. No matter if you are on snow or water, polarized lenses give you the freedom to enjoy your life outdoors. Contrasts and colours appear more intense. Visual clarity and comfort are increased.

SHARPER CONTRASTS

BRILLIANT COLOURS

REDUCED EFFECTS OF GLARE

MORE ACTION



WING SYSTEM

The patented WING system combines two temple elements in one frame. By moving a small slider on the temple, a second hidden metal wire extends out and wraps around the ear.

The second temple provides secure fit grip during high-level sports activities. Through its curly form, the flexible wire securely hugs the ear. In the same way as it extends, the wire slides back until it completely disappears inside the temple again – without once removing the frame from the head. The innovative WING system is specially developed for high movement sports and tested by leading Red Bull Athletes around the globe.

BLADE



BLADE-001P
Front & Temple: shiny black
Lens: brown with red mirror, CAT3, AR, POL

TOPSELLER



BLADE-002P
Front & Temple: matt black
Lens: smoke with ice blue mirror, CAT3, AR, POL

TOPSELLER



BLADE-006P
Front & Temple: shiny x'tal warm grey
Lens: brown with bronze mirror, CAT3, AR, POL

TOPSELLER



BLADE-003P
Front & Temple: matt black
Lens: smoke, CAT3, AR, POL



BLADE-004P
Front & Temple: shiny x'tal grey
Lens: smoke with silver mirror, CAT3, AR, POL



BLADE-005P
Front & Temple: shiny x'tal clear
Lens: smoke with ice blue mirror, CAT3, AR, POL

Size: M (56-16-140)

Shape: Square

POLAR 

Frame: TR90

RX-able: yes

WING 

REACH



REACH-002P
Front & Temple: matt black
Lens: smoke with ice blue mirror, CAT3, AR, POL

TOPSELLER



REACH-001P
Front & Temple: shiny black
Lens: brown with red mirror, CAT3, AR, POL

TOPSELLER



REACH-003P
Front & Temple: matt black
Lens: brown with bronze mirror, CAT3, AR, POL

TOPSELLER



REACH-004P
Front & Temple: shiny x'tal grey
Lens: smoke with silver mirror, CAT3, AR, POL



REACH-005P
Front & Temple: matt black
Lens: smoke, CAT3, AR, POL



REACH-006P
Front & Temple: shiny dk havana
Lens: smoke with olive mirror, CAT3, AR, POL

Size: L (58-18-140)

Shape: Soft Square

POLAR 

Frame: TR90

RX-able: yes

WING DTS

BOW



BOW-002P
Front & Temple: shiny black
Lens: brown with red mirror, CAT3, AR, POL

TOPSELLER



BOW-001P
Front & Temple: matt black
Lens: smoke, CAT3, AR, POL

TOPSELLER



BOW-003P
Front & Temple: matt blue
Lens: smoke with blue mirror, CAT3, AR, POL



BOW-004P
Front & Temple: matt dark grey transparent/
matt dark grey solid
Lens: blue with silver flash, CAT3, AR, POL



BOW-006P
Front & Temple: matt havana
Lens: brown with bronze mirror, CAT3, AR, POL



BOW-007P
Front & Temple: shiny black
Lens: smoke with light blue mirror, CAT3, AR, POL

TOPSELLER

Size: L (59-16-145)

Shape: Square

POLAR 

Frame: TR90

RX-able: yes

WING 

STEADY



STEADY-006P
Front & Temple: matt black
Lens: smoke with green mirror, CAT3, AR, POL

TOPSELLER



STEADY-002P
Front & Temple: matt blue
Lens: brown with red mirror, CAT3, AR, POL



STEADY-004P
Front & Temple: matt warm grey
Lens: brown with peach mirror, CAT3, AR, POL



STEADY-005P
Front & Temple: matt havana
Lens: smoke with light blue mirror, CAT3, AR, POL

TOPSELLER



STEADY-007P
Front & Temple: shiny black
Lens: brown with red mirror, CAT3, AR, POL

TOPSELLER



STEADY-008P
Front & Temple: shiny black
Lens: smoke with light blue mirror, CAT3, AR, POL

TOPSELLER

Size: M (51-19-145)

Shape: Panto

POLAR 

Frame: TR90

RX-able: yes

WING DTS

FLY



FLY-001P
Front & Temple: matt black
Lens: brown with bronze mirror, CAT3, AR, POL

TOPSELLER



FLY-005P
Front & Temple: matt havana
Lens: smoke with lilac mirror, CAT3, AR, POL

TOPSELLER



FLY-006P
Front & Temple: matt blue
Lens: smoke with silver mirror, CAT3, AR, POL



FLY-007P
Front & Temple: shiny transparent anthracite
Lens: green with silver flash, CAT3, AR, POL



FLY-008P
Front & Temple: shiny black
Lens: smoke with blue mirror, CAT3, AR, POL

TOPSELLER

Size: M (54-17-145)

Shape: Cateye

POLAR 

Frame: TR90

RX-able: yes

WING 

SPORT

SPEED
DESIGNED TO

**LIVIN'
PERFORM**
RED BULL



RAZE



RAZE-005P (SIGNATURE EDITION)
Front & Temple: matt x'tal black
Lens: brown with red mirror, CAT3, POL

TOPSELLER



RAZE-001P
Front & Temple: shiny x'tal black
Lens: smoke with blue mirror, CAT3, POL

TOPSELLER



RAZE-002P
Front & Temple: shiny havana
Lens: brown with light bronze mirror, CAT3, POL



RAZE-003P
Front & Temple: shiny x'tal grey
Lens: green with green mirror, CAT3, POL



RAZE-004P
Front & Temple: shiny x'tal light grey
Lens: smoke with ice blue mirror, CAT3, POL



RAZE-006P (SIGNATURE EDITION)
Front & Temple: matt black
Lens: smoke, CAT3, POL

TOPSELLER

Size: M (61-16-130)

Shape: Round/Base 8

POLAR 

Frame: TR90/Rubber

SLC

BOLT



BOLT-001P
Front & Temple: shiny x'tal grey
Lens: smoke with blue mirror, CAT3, POL

TOPSELLER



BOLT-002P
Front & Temple: shiny havana
Lens: brown with light bronze mirror, CAT3, POL

TOPSELLER



BOLT-005P
Front & Temple: shiny x'tal dark brown
Lens: brown with red mirror, CAT3, POL

TOPSELLER



BOLT-003P
Front & Temple: shiny black
Lens: brown with bronze mirror, CAT3, POL



BOLT-004P
Front & Temple: shiny x'tal grey
Lens: blue with silver flash, CAT3, POL



BOLT-006P
Front & Temple: matt black
Lens: smoke, CAT3, POL

Size: L (61-16-130)

Shape: Square/Base 8

POLAR 

Frame: TR90/Rubber

SLC

DRIFT



DRIFT-002P
Front & Temple: shiny x'tal grey/black rubber
Lens: smoke, CAT3, POL

TOPSELLER



DRIFT-001P
Front & Temple: shiny x'tal grey/black rubber
Lens: brown with bronze mirror, CAT3, POL



DRIFT-003P
Front & Temple: shiny x'tal clear/light grey rubber
Lens: smoke with ice blue mirror, CAT3, POL



DRIFT-004P
Front & Temple: shiny black/black rubber
Lens: brown with red mirror, CAT3, POL

TOPSELLER



DRIFT-005P (SIGNATURE EDITION)
Front & Temple: shiny x'tal clear/olive green rubber
Lens: brown with orange mirror, CAT3, POL, AR coating
Packaging with extra cleaning cloth, case, hardcover box.



DRIFT-006P (SIGNATURE EDITION)
Front & Temple: shiny x'tal grey/blue rubber
Lens: smoke with blue mirror, CAT3, POL, AR coating
Packaging with extra cleaning cloth, case, hardcover box.

TOPSELLER

Size: M (61-14-130)

Shape: Round/Base 8

POLAR 

Frame: TR90/Rubber

SLC

PERFORMANCE

FLOW
DESIGNED TO

SUCCEED



DAFT



DAFT-005
Front & Temple: shiny black
Lens: purple-green revo, CAT3

TOPSELLER



DAFT-001
Front & Temple: rubber black
Lens: smoke, CAT3



DAFT-002
Front & Temple: shiny white
Lens: red revo, CAT3

TOPSELLER



DAFT-003
Front & Temple: matt metallic black
Lens: silver revo, CAT3



DAFT-004
Front & Temple: rubber blue
Lens: ice blue revo, CAT3

TOPSELLER



DAFT-006
Front & Temple: rubber olive
Lens: smoke, CAT3

**NEW
STYLE**

Size: M (137-130)

Shape: Mono (Shield)

Frame: TR90

RX-able: no

DAKOTA



DAKOTA-001
Front & Temple: rubber black
Lens: smoke, CAT3



DAKOTA-002
Front & Temple: shiny white
Lens: ice blue revo, CAT3

TOPSELLER



DAKOTA-004
Front & Temple: matt metallic blue
Lens: red revo, CAT3

TOPSELLER



DAKOTA-005
Front & Temple: shiny red
Lens: smoke, CAT3



DAKOTA-006
Front & Temple: matt metallic blue
Lens: silver revo, CAT3

TOPSELLER

**NEW
STYLE**

Size: M (137-130)

Shape: Mono (Shield)

Frame: TR90

RX-able: no

JADEN

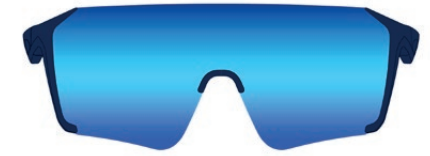

JADEN-001
Front & Temple: shiny and matt black
Lens: photochromic, CAT1-3

TOPSELLER

JADEN-002
Front & Temple: shiny and matt blue
Lens: ice blue revo, CAT3

TOPSELLER

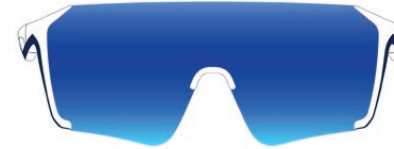

JADEN-004
Front & Temple: matt white and blue
Lens: dark blue revo, CAT3



JADEN-005
Front & Temple: matt black and red
Lens: red revo, CAT3

TOPSELLER



JADEN-006
Front & Temple: shiny x'tal dark grey and black
Lens: purple-green revo, CAT3

**NEW
STYLE**

JADEN-003
Front & Temple: matt black
Lens: smoke, CAT3

Size: M/L (140-144)

Shape: Mono (Shield)

Frame: TR90

RX-able: yes (clip available)

NICK



NICK-005
Front & Temple: shiny and matt red
Lens: red revo, CAT3



NICK-001
Front & Temple: matt black
Lens: photochromic, CAT1-3
TOPSELLER



NICK-002
Front & Temple: matt blue
Lens: red revo, CAT3
TOPSELLER



NICK-003
Front & Temple: matt white and black
Lens: smoke, CAT3



NICK-004
Front & Temple: shiny blue and grey
Lens: ice blue revo, CAT3
TOPSELLER



NICK-006
Front & Temple: shiny x'tal dark grey and black
Lens: silver revo, CAT3

**NEW
STYLE**

Size: M/L (140-144)

Shape: Mono (Shield)

Frame: TR90

RX-able: yes (clip available)



FLOW STYLES

Endurance sports are demanding in every aspect.
So why not add some comfort?

By detaching the lens from the lower frame, a free-floating lens effect is created, our patented FLOW system. The elastic characteristics of the frame allow the lens to freely move up and down while being exposed to movement or shocks. Combined with adjustable rubber nose pads and temple tips, a robust and lightweight TR90 frame and an open frame design for perfect airflow, these glasses are made for performance.

FLOW



FLOW-001
Front: matt white
Temple: matt blue
Lens: smoke with blue mirror, second lens transparent

TOPSELLER



FLOW-002
Front: shiny red
Temple: shiny blue
Lens: smoke with red mirror, second lens transparent

TOPSELLER



FLOW-004
Front & Temple: matt black
Lens: grey with purple mirror, second lens transparent

Size: M (135-0-125)

Shape: Shield/Base 8

FLOW FLS

Frame: TR90/Rubber

Polycarbonate Lens

PACE



PACE-006
Front & Temple: shiny black
Lens: smoke with red mirror, second lens transparent

TOPSELLER



PACE-001
Front & Temple: matt blue
Lens: smoke with blue mirror, second lens transparent

TOPSELLER



PACE-002
Front & Temple: shiny white
Lens: transparent photocromic, CAT1-2



PACE-003
Front & Temple: matt black
Lens: smoke with bronze mirror, second lens transparent

TOPSELLER

Size: L (135-0-125)

Shape: Shield/Base 8

FLOW FLS

Frame: TR90/Rubber

Polycarbonate Lens

LIFESTYLE

SHOUT
MADE TO

IT'S ALWAYS
IMPRESS



LEAP



LEAP-003P
Front & Temple: matt black rubberised
Lens: smoke with ice blue mirror, CAT3, POL

TOPSELLER



LEAP-001P
Front & Temple: matt dark blue rubberised
Lens: smoke with blue mirror, CAT3, POL



LEAP-002P
Front & Temple: matt crystal grey rubberised
Lens: smoke with olive purple mirror, CAT3, POL



LEAP-004P
Front: matt black rubberised
Temple: matt transparent green rubberised
Lens: green, CAT3, POL

TOPSELLER



LEAP-006P
Front & Temple: matt olive green rubberised
Lens: brown with red mirror, CAT3, POL

TOPSELLER



LEAP-007P
Front & Temple: shiny x'tal
Lens: smoke with turquoise mirror, CAT3, POL

Size: M (55-17-145)

Shape: Square

POLAR 

Frame: TR90

RX able: yes

LAKE



LAKE-001P
Front & Temple: matt dark blue rubberised
Lens: smoke with blue mirror, CAT3, POL

TOPSELLER



LAKE-002P
Front & Temple: matt black rubberised
Lens: smoke with gold mirror, CAT3, POL

TOPSELLER



LAKE-003P
Front & Temple: matt crystal grey rubberised
Lens: smoke with red mirror, CAT3, POL



LAKE-004P
Front & Temple: matt black rubberised
Lens: smoke with green mirror, CAT3, POL

TOPSELLER



LAKE-005P
Front & Temple: matt grey rubberised
Lens: smoke with silver mirror, CAT3, POL



LAKE-006P
Front & Temple: matt crystal
Lens: smoke with turquoise mirror, CAT3, POL



LAKE-007P
Front & Temple: shiny x'tal
Lens: brown with red mirror, CAT3, POL

Size: M (54-19-145)

Shape: Square

POLAR 

Frame: TR90

RX able: yes

LACE



LACE-001P
Front & Temple: matt black rubberised
Lens: smoke with gold flash, CAT3, POL

TOPSELLER



LACE-003P
Front & Temple: matt havana rubberised
Lens: smoke with silver mirror, CAT3, POL

TOPSELLER



LACE-006P
Front & Temple: matt olive green rubberised
Lens: smoke with silver mirror, CAT3, POL

LACE-008P
Front & Temple: shiny x'tal
Lens: smoke with light blue mirror, CAT3, POL

LACE-004P
Front & Temple: matt black rubberised
Lens: smoke with red mirror, CAT3, POL

TOPSELLER



LACE-009P
Front & Temple: shiny black
Lens: smoke with blue mirror, CAT3, POL

Size: M (53-20-145)

Shape: Round

POLAR 

Frame: TR90

RX able: yes

SPARK



SPARK-002P
Front & Temple: transparent black
Lens: smoke with blue mirror, CAT3, POL

TOPSELLER



SPARK-001P
Front & Temple: matt black
Lens: green, CAT3, POL

TOPSELLER



SPARK-003P
Front & Temple: matt dark blue
Lens: brown with red mirror, CAT3, POL



SPARK-004P
Front & Temple: matt transparent olive
Lens: smoke with green mirror, CAT3, POL



SPARK-005P
Front & Temple: shiny x'tal
Lens: smoke, CAT3, POL



SPARK-006P
Front & Temple: matt black
Lens: smoke with ice blue mirror, CAT3, POL

TOPSELLER

Size: M (54-17-145)

Shape: Square

POLAR 

Frame: TR90

RX able: yes

LOOM



LOOM-001P
Front & Temple: matt black rubberised
Lens: brown with red mirror, CAT3, POL

TOPSELLER



LOOM-003P
Front & Temple: matt green rubberised
Lens: smoke with silver mirror, CAT3, POL



LOOM-004P
Front & Temple: matt white rubberised
Lens: brown with red mirror, CAT3, POL



LOOM-005P
Front & Temple: matt black rubberised
Lens: smoke with green mirror, CAT3, POL

TOPSELLER



LOOM-007P
Front & Temple: matt blue rubberised
Lens: smoke with blue mirror, CAT3, POL

TOPSELLER



LOOM-008P
Front & Temple: shiny black
Lens: smoke with light blue mirror, CAT3, POL



LOOM-009P
Front & Temple: shiny x'tal
Lens: smoke with light blue mirror, CAT3, POL

Size: L (62-14-127)

Shape: Square/Base 8

POLAR 

Frame: TR90

RX able: yes

SONIC



SONIC-001P
Front & Temple: matt black
Lens: smoke, CAT3, POL

TOPSELLER



SONIC-002P
Front & Temple: matt black
Lens: smoke with dark blue mirror, CAT3, POL

TOPSELLER



SONIC-003P
Front & Temple: matt blue
Lens: brown with red mirror, CAT3, POL

TOPSELLER



SONIC-004P
Front & Temple: shiny transparent anthracite
Lens: smoke with orange mirror, CAT3, POL



SONIC-005P
Front & Temple: shiny x'tal
Lens: smoke with ice blue mirror, CAT3, POL

Size: L (59-17-130)

Shape: Soft Square/Base 8

POLAR 

Frame: TR90

RX able: yes

SOUL



SOUL-005P
Front & Temple: shiny x'tal
Lens: smoke with light blue mirror, CAT3, POL

TOPSELLER



SOUL-001P
Front & Temple: shiny gradient anthracite
Lens: gradient smoke, CAT3, POL



SOUL-002P
Front & Temple: matt black
Lens: smoke with blue mirror CAT3, POL

TOPSELLER



SOUL-003P
Front & Temple: matt gradient olive to havana
Lens: brown with bronze mirror, CAT3, POL

TOPSELLER



SOUL-004P
Front & Temple: matt black
Lens: green, CAT3, POL



SOUL-006P
Front & Temple: matt brown havana
Lens: smoke with gold flash, CAT3, POL



SOUL-007P
Front & Temple: shiny x'tal black
Lens: smoke with red mirror, CAT3, POL

Size: S (48-19-145)

Shape: Round

POLAR 

Frame: TR90

RX able: yes

(MPO)



SHOUT RX

The new SHOUT RX collection combines sporty lifestyle frames with high-quality corrective lenses. All models of the RX series can be offered with the identical mirrors in your individual prescription. Two quality products from a single source. With the complete glasses we offer modern frames combined with high-quality MPO premium glasses. Highest quality and the most modern technology Made in Germany.



CARY_RX



CARY_RX-002P
Front & Temple: shiny x'tal grey
Lens: blue green mirror, CAT3, POL

TOPSELLER



CARY_RX-001P
Front & Temple: matt black
Lens: green, CAT3, POL



CARY_RX-003P
Front & Temple: shiny havana
Lens: brown, CAT3, POL



CARY_RX-004P
Front & Temple: shiny black
Lens: smoke, CAT3, POL

TOPSELLER

**NEW
STYLE**

Size: L (57-16-145)

Shape: Square

POLAR 

Frame: TR90

RX-able: yes

COBY_RX



COBY_RX-001P
Front & Temple: matt black
Lens: sky blue mirror, CAT3, POL



COBY_RX-002P
Front & Temple: matt olive to havana
Lens: champagne gold mirror, CAT3, POL



COBY_RX-003P
Front & Temple: shiny x'tal anthracite
Lens: red mirror, CAT3, POL

TOPSELLER



COBY_RX-004P
Front & Temple: shiny black
Lens: smoke, CAT3, POL

TOPSELLER

**NEW
STYLE**

Size: S/M (50-16-145)

Shape: Round

POLAR 

Frame: TR90

RX-able: yes

COOPER_RX



COOPER_RX-003P
Front & Temple: matt olive green
Lens: red mirror, CAT3, POL

TOPSELLER



COOPER_RX-001P
Front & Temple: matt black
Lens: smoke, CAT3, POL



COOPER_RX-002P
Front & Temple: shiny x'tal black
Lens: blue grey mirror, CAT3, POL

TOPSELLER



COOPER_RX-004P
Front & Temple: shiny black
Lens: sky blue mirror, CAT3, POL

**NEW
STYLE**

Size: M/L (55-15-145)

Shape: Rectangular

POLAR 

Frame: TR90

RX-able: yes

CONOR_RX



CONOR_RX-003P
Front & Temple: matt black
Lens: smoke, CAT3, POL



CONOR_RX-001P
Front & Temple: matt black
Lens: sky blue mirror, CAT3, POL

TOPSELLER



CONOR_RX-002P
Front & Temple: shiny black
Lens: red mirror, CAT3, POL

TOPSELLER



CONOR_RX-004P
Front & Temple: shiny x'tal
Lens: mojito mirror, CAT3, POL

**NEW
STYLE**

Size: L (57-15-145)

Shape: Rectangular

POLAR 

Frame: TR90

RX-able: yes

CASEY_RX



CASEY_RX-002P
Front & Temple: shiny havana
Lens: champagne gold mirror, CAT3, POL



CASEY_RX-001P
Front & Temple: shiny black
Lens: red mirror, CAT3, POL
TOPSELLER



CASEY_RX-003P
Front & Temple: matt black
Lens: smoke, CAT3, POL
TOPSELLER



CASEY_RX-004P
Front & Temple: matt black
Lens: sky blue mirror, CAT3, POL

**NEW
STYLE**

Size: L (58-13-145)

Shape: Rectangular

POLAR 

Frame: TR90

RX-able: yes

DIRT

MX / DH
DESIGNED TO

PROTECT



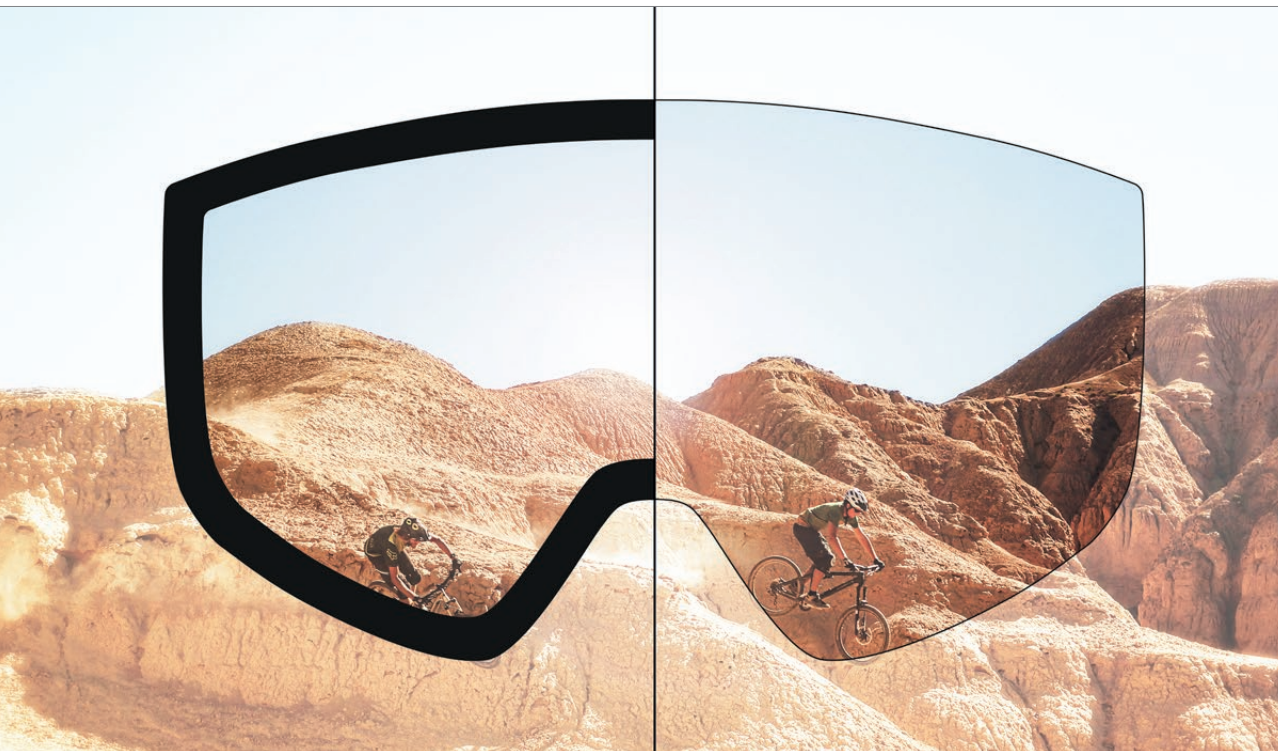

STANDARD LENS

PANO TECH
15% INCREASED VISION

FOR ULTIMATE PANO VISION

The missing link when it comes to high performance cylindrical lenses. The LINK double lenses are **laminated** together and offer a **panoramic** field of vision by skipping the additional foam layer that creates the airspace.

No reflections, no distortions, no refractions.

In combination with a thin frame design it offers an up to 15% increased field of vision by avoiding the „tunnel view“ that results with thick frames that have the lens sit far away from the face.

No fogging. The Ultra-AF inner lens withstands fogging over 180 seconds and exceeds the required standards of 30 seconds by factor 6.

STRIVE



STRIVE-004S
 Colour: matt black – black headband
 Lens: brown with red mirror, red flash, CAT2

TOPSELLER



STRIVE-001S
 Colour: matt dark blue – dark blue headband
 Lens: brown with blue mirror, blue flash CAT2

TOPSELLER



STRIVE-002S
 Colour: matt white – white headband
 Lens: clear flash, CAT0



STRIVE-003S
 Colour: matt black – black headband
 Lens: smoke with silver flash, black flash CAT2



STRIVE-005S
 Colour: matt light grey – light blue headband
 Lens: light smoke, light grey flash, CAT1



STRIVE-006S
 Colour: matt red – red headband
 Lens: purple with red mirror, purple red flash, CAT2

TOPSELLER



STRIVE-007S
 Colour: matt dark blue – dark blue headband
 Lens: clear, CAT0

NEW COLOR

Size: L

FaceFoamXchange

I BOOST

PANO TECH

Frame: TPU

FREE

F SCAPE

Double Lens

**+ 1 FACE FOAM
 + 1 SINGLE CLEAR LENS**

STRIVE



STRIVE-008S
Colour: matt blue – blue/red headband
Lens: blue Cat.2



STRIVE-009S
Colour: matt red – red/black headband
Lens: red Cat.2



STRIVE-010S
Colour: matt orange – black/orange headband
Lens: purple Cat.2



STRIVE-011S
Colour: matt black – black/blue headband
Lens: silver Cat.1

**NEW
PRICEPOINT**

NEW COLORS

Size: L

Single Lens

F SCAPE

Frame: TPU

FREE

STRIVE



STRIVE-012S
Colour: shiny black – black/blue headband
Lens: clear Cat.0



STRIVE-013S
Colour: shiny dark blue – blue/red headband
Lens: clear Cat.0



STRIVE-014S
Colour: shiny red – red/black headband
Lens: clear Cat.0



STRIVE-015S
Colour: shiny orange – black/orange headband
Lens: clear Cat.0

**NEW
PRICEPOINT**

NEW COLORS

Size: L

Single Lens

F SCAPE

Frame: TPU

FREE

WHIP



WHIP-001
Colour: matt blue – blue headband
Lens: grey with blue mirror, blue flash CAT2

TOPSELLER



WHIP-002
Colour: matt black – grey headband
Lens: clear flash, CAT0

+ 1 PACK TEAR-OFFS



WHIP-005
Colour: matt red – blue red headband
Lens: amber with red mirror, light red flash CAT2

TOPSELLER

Size: M

Shape: Cylindrical

Tear-off Lens System

FREE

Frame: TPU

RX Clip-in available

F SCAPE

Double Lens

+ 1 SINGLE CLEAR LENS

WHIP



WHIP-008
Colour: shiny red – white headband
Lens: clear flash, CAT0

TOPSELLER



WHIP-009
Colour: shiny neon yellow – blue headband
Lens: clear flash, CAT0



WHIP-010
Colour: shiny neon blue – bright blue headband
Lens: clear flash, CAT0



WHIP-011
Colour: shiny dark blue – blue/colored headband
Lens: clear Cat.0



WHIP-012
Colour: shiny black – black/colored headband
Lens: clear Cat.0



WHIP-013
Colour: shiny white – white/colored headband
Lens: clear Cat.0

NEW COLORS

Size: M

Shape: Cylindrical

Tear-off Lens System

FREE

Frame: TPU

RX Clip-in available

F SCAPE

ADDITIONAL & SPARE PARTS

ROLL-OFF-SYSTEM, TEAR-OFF-SYSTEM, FACEFOAM, HEADBANDS



STRIVE-HEADBAND1



STRIVE-HEADBAND2



STRIVE-HEADBAND3



STRIVE-HEADBAND4



STRIVE-HEADBAND5



STRIVE-HEADBAND6



STRIVE-HEADBAND7



STRIVE-HEADBAND8



STRIVE-HEADBAND9



STRIVE-HEADBAND10



ROLL-OFF-SYSTEM WITH LENS & 1 ROLL OF FILM
(STRIVE-ROLLCLEARLENS)



SPARE ROLL OFF FILM 3 PIECES SET
(STRIVE-ROLLFILM3)



SPARE TEAR OFF FILM
(STRIVE-TEAROFFFILM)



SPARE FACE FOAM
(STRIVE-FACEFOAM)

STRIVE LENSES

INTERCHANGEABLE LENSES

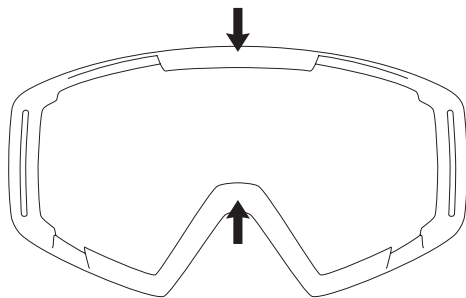
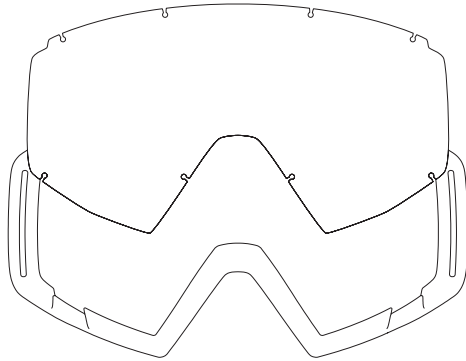
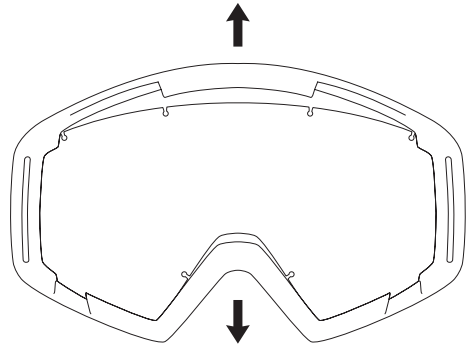

**SPARE LENS CLEAR FLASH
(STRIVE-CLEARLENS)**



**CLEAR FLASH WITH ANTI-FOG
(STRIVE-CLEARLENSAF)**



**SPARE LENS LIGHT GREY FLASH
(STRIVE-005LENS)**

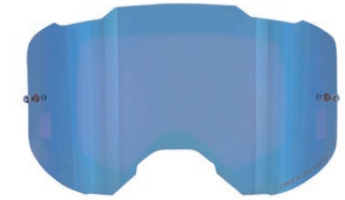

**SPARE LENS BLUE FLASH
(STRIVE-001LENS)**

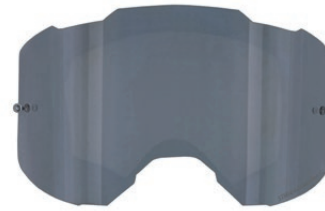

**SPARE LENS BLACK FLASH
(STRIVE-003LENS)**

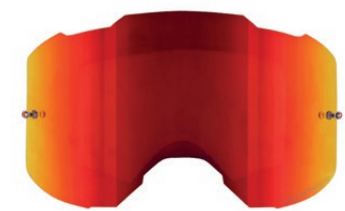

**SPARE LENS RED FLASH
(STRIVE-004LENS)**



**SPARE LENS PURPLE RED FLASH
(STRIVE-006LENS)**

WHIP LENSES/TEAR-OFF-SYSTEM

INTERCHANGEABLE LENSES AND SPARE PARTS

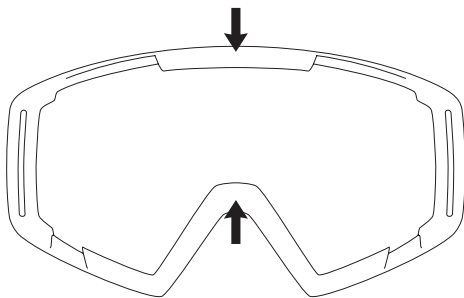
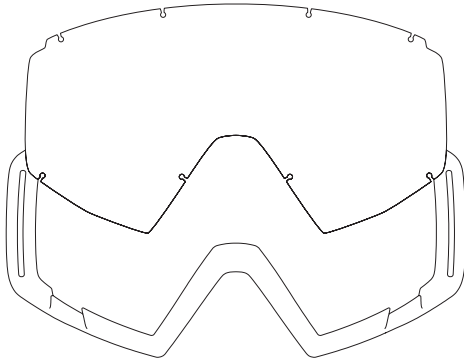
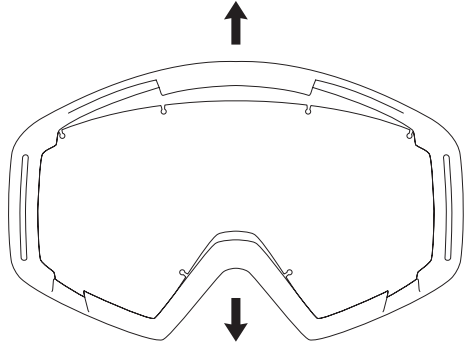

SPARE LENS CLEAR FLASH
(WHIP-002LENS)



SPARE LENS GREY FLASH
(WHIP-006LENS)

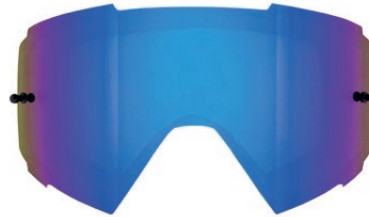

SPARE LENS BLUE FLASH
(WHIP-001LENS)

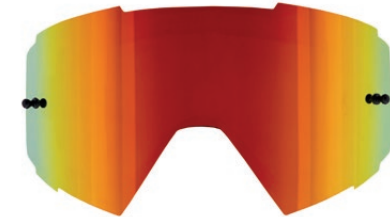

SPARE LENS RED FLASH
(WHIP-005LENS)

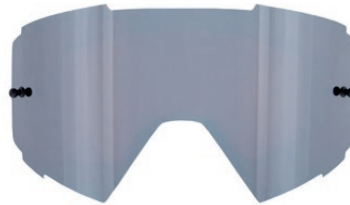























SPARE LENS SILVER FLASH
(WHIP-003LENS)



SPARE TEAR OFF FILM 10 PCS
(WHIP-TEAROFFFILM)

LENS DETAILS

ITEM NO.	LENS	COLOUR	HYDROPHOBIC	ANTI-FOG	WEATHER CONDITION	FILTER CATEGORY	VISIBLE LIGHT TRANSMITTANCE
STRIVE-001S	DOUBLE	BLUE FLASH	YES	YES		CAT2	18 %
STRIVE-002S	DOUBLE	CLEAR FLASH	YES	YES		CAT0	93 %
STRIVE-003S	DOUBLE	BLACK FLASH	YES	YES		CAT2	30 %
STRIVE-004S	DOUBLE	RED FLASH	YES	YES		CAT2	23 %
STRIVE-005S	DOUBLE	LIGHT GREY FLASH	YES	YES		CAT1	57 %
STRIVE-006S	DOUBLE	PURPLE RED FLASH	YES	YES		CAT2	21 %
STRIVE-007S	DOUBLE	CLEAR FLASH	YES	YES		CAT0	93 %
STRIVE-008S	SINGLE	BLUE FLASH	YES	YES		CAT2	21 %
STRIVE-009S	SINGLE	RED FLASH	YES	YES		CAT2	27 %
STRIVE-010S	SINGLE	PURPLE RED FLASH	YES	YES		CAT2	24 %
STRIVE-011S	SINGLE	BLACK FLASH	YES	YES		CAT2	30 %
STRIVE-012S	SINGLE	CLEAR FLASH	YES	YES		CAT0	93 %
STRIVE-013S	SINGLE	CLEAR FLASH	YES	YES		CAT0	93 %
STRIVE-014S	SINGLE	CLEAR FLASH	YES	YES		CAT0	93 %
STRIVE-015S	SINGLE	CLEAR FLASH	YES	YES		CAT0	93 %
WHIP-001	SINGLE	BLUE FLASH	YES	YES		CAT2	18 %
WHIP-002	SINGLE	CLEAR FLASH	YES	YES		CAT0	93 %
WHIP-008	SINGLE	CLEAR FLASH	YES	YES		CAT0	93 %
WHIP-009	SINGLE	CLEAR FLASH	YES	YES		CAT0	93 %
WHIP-010	SINGLE	CLEAR FLASH	YES	YES		CAT0	93 %
WHIP-011	SINGLE	CLEAR FLASH	YES	YES		CAT0	93 %
WHIP-012	SINGLE	CLEAR FLASH	YES	YES		CAT0	93 %
WHIP-013	SINGLE	CLEAR FLASH	YES	YES		CAT0	93 %



DISTRIBUITO DA

SST[®]

ENGINEERING SOLUTIONS

WWW.SST-ITALIA.IT

